

Data Sheet



Article number: 03445080

Description: Fluro Heavy Duty Spherical Plain Bearing GE 80 EW-2RS
Hole Ø80

Note: 80

Measures

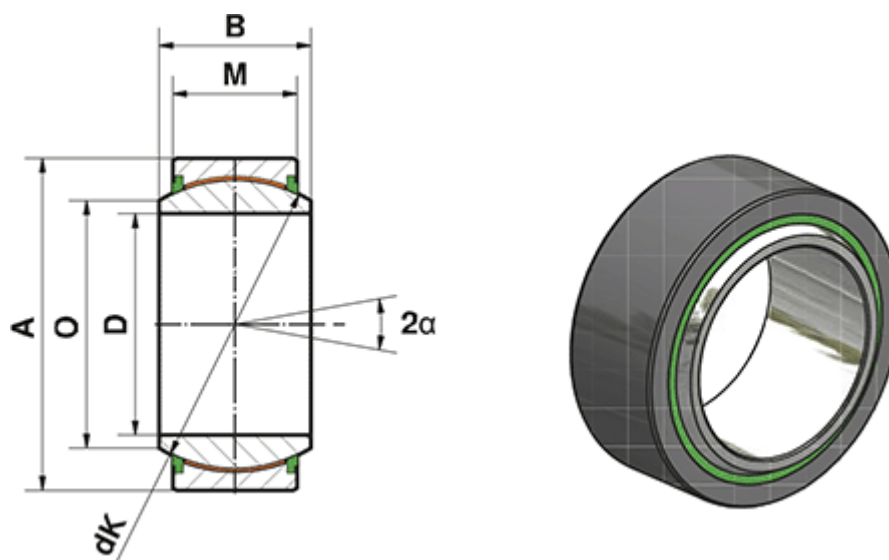

A	= 120	Static load C0 (kN) = 1875
a (degrees)	= 6	Weight (g) = 2200
B	= 55	
D	= 80	
dk	= 105	
Dynamic load C (kN)	= 1125	
M	= 45	
O	= 89.4	